

铸百年卓越海亮 创国际经典品牌

Forging an Everlasting Outstanding Hailiang
Creating an International Classical Brand

A wide-angle photograph of a sunset over the ocean. The sun is low on the horizon, casting a golden glow across the sky and reflecting on the water. The waves are breaking gently on a sandy beach in the foreground. The sky transitions from a deep blue at the top to a bright orange near the horizon.

中国·海亮

Reliability and supply of 5 mm copper tubes

- 1** ***HAILIANG Co., Ltd. Introduction***
- 2** ***HAILIANG Products***
- 3** ***Production Process***
- 4** ***Product Specifications Range***
- 5** ***Supply of 5 mm copper tubes***
- 6** ***HAILIANG Contact***

1 HAILIANG Co., Ltd. Introduction

ZHEJIANG HAILIANG Co., Ltd.

Date	History
Year 2001	Established, the former factory is Hailiang Copper Factory which set up in 1997.
16 th . Jan. 2008	Shenzhen Stock Exchange public listing; the stock code is 002203.
31 st . Dec. 2017	Staff:6330 people; Total asset is 15.28 billion RMB; Annual revenue is 29.91 billion RMB.

Listing Ceremony



Industrial Distribution

ZheJiang Copper **Co., Ltd.**

ShangHai Copper **Co., Ltd.**

AnHui Copper **Co., Ltd.**

GuangDong Copper **Co., Ltd.**

Hailiang(Vietam) Copper
Manufacturing **Co., Ltd.**

Hailiang Otto Copper
(Thailand) Co., Ltd.

Hailiang Otto Copper
(GuangDong) Co., Ltd.

ChongQing Copper **Co., Ltd.**

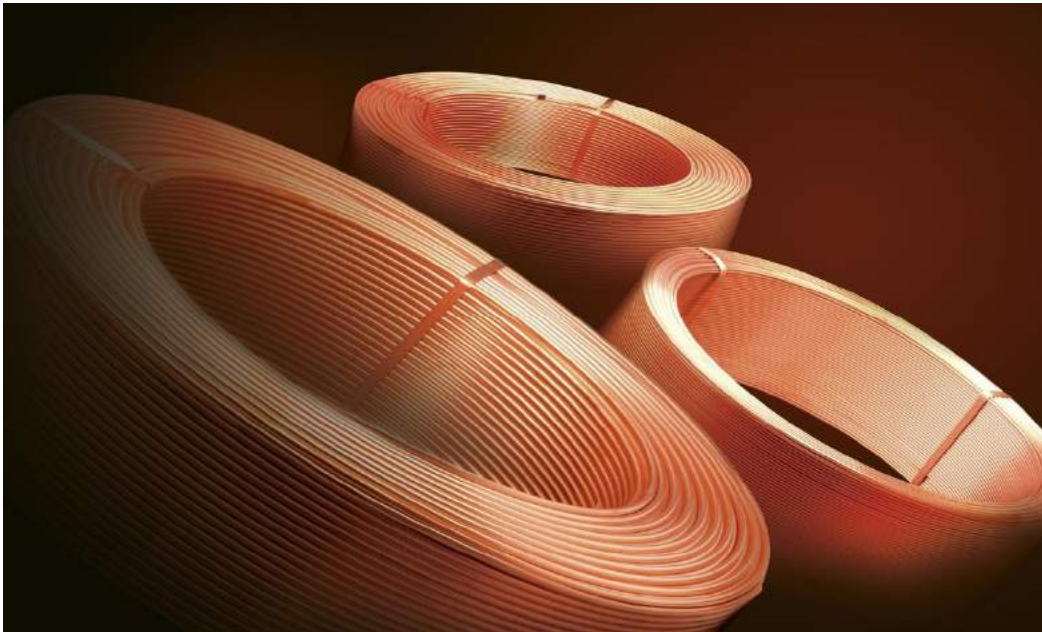

LWC

Insulated Copper Tubes



Pancake Coils



Capillary

INNER GROOVED

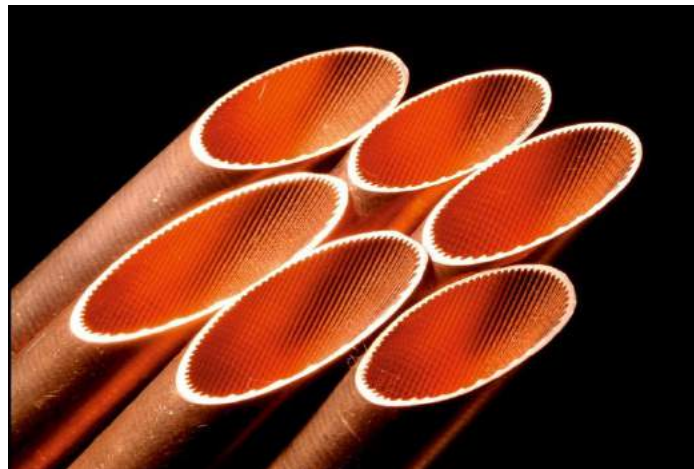



Copper and Brass Fitting

Copper Water Tubes



**Air Conditioning
Straight Tubes**



Brass tube

Plastic-Coated Copper Tubes



**Copper
Aluminum Bar**

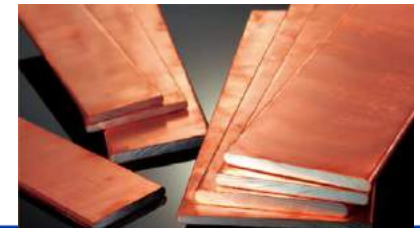

Copper Rod

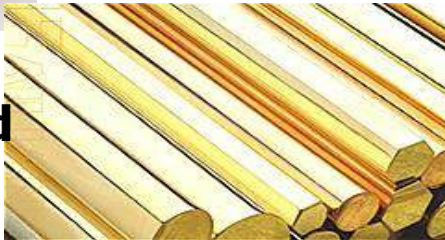

3. Production Process

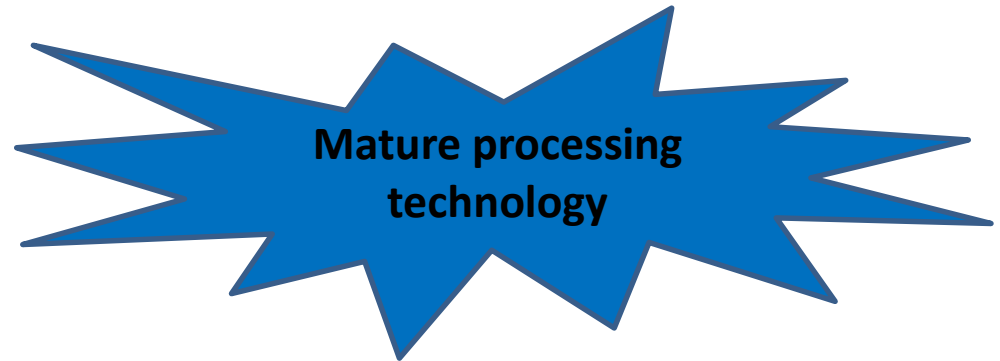
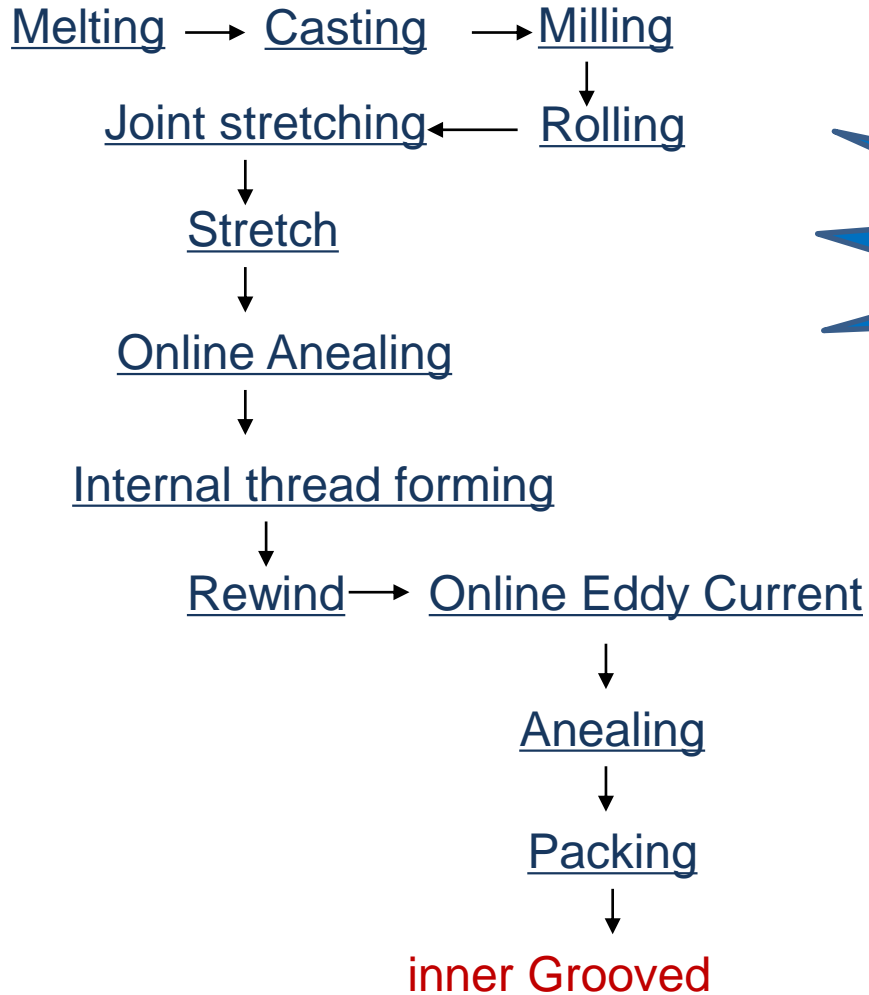

Hailiang produces inner Grooved tubes as seamless inner grooved copper tubes. The forming technology is high-precision blank tube ultra-high speed spinning inner grooved forming.

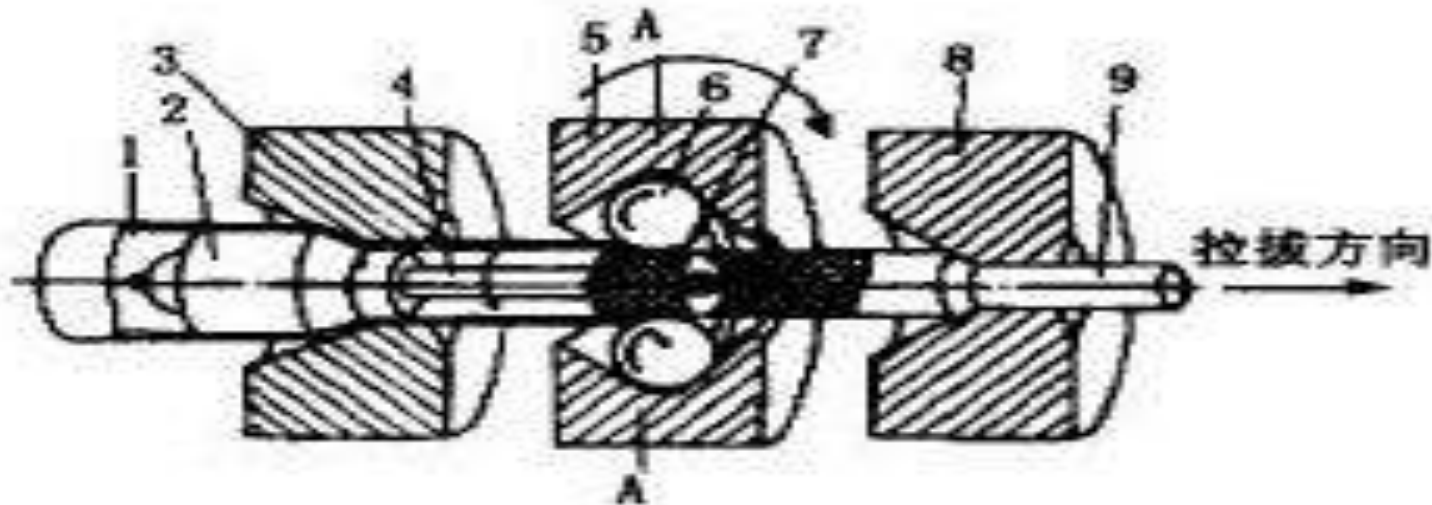

- 1.Mother Tube
- 2.Swimming core
- 3.Reduced mold
- 4.Core rod
- 5.High speed spinning ring
- 6.Steel ball
- 7.Inner Grooved core
- 8.Fixed outer diameter mold
- 9.Finished tube

4.Product Specifications Range

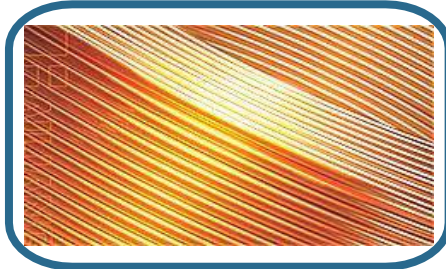
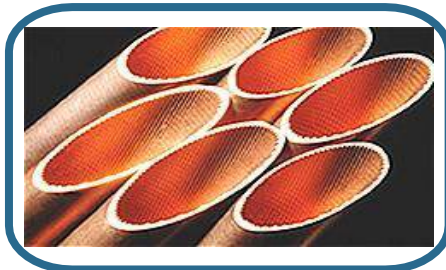

O.D.(Inch) [↕]		Bottom Wall Thickness Tw [↕]		Fin Groove Depth Hf [↕]	
Inch [↕]	mm [↕]	Inch [↕]	mm [↕]	Inch [↕]	mm [↕]
0.1970 [↕]	5 [↕]	0.008 [↕] ~ 0.014 [↕]	0.20 ~ 0.35 [↕]	0.004 [↕] ~ 0.006 [↕]	0.10 ~ 0.15 [↕]
0.2363 [↕]	6 [↕]	0.008 [↕] ~ 0.014 [↕]	0.20 ~ 0.35 [↕]	0.004 [↕] ~ 0.008 [↕]	0.10 ~ 0.20 [↕]
0.2500 [↕]	6.35 [↕]	0.008 [↕] ~ 0.014 [↕]	0.20 ~ 0.35 [↕]	0.004 [↕] ~ 0.008 [↕]	0.10 ~ 0.20 [↕]
0.2750 [↕]	7 [↕]	0.010 [↕] ~ 0.016 [↕]	0.20 ~ 0.41 [↕]	0.004 [↕] ~ 0.010 [↕]	0.10 ~ 0.25 [↕]
0.3125 [↕]	7.94 [↕]	0.010 [↕] ~ 0.016 [↕]	0.20 ~ 0.41 [↕]	0.004 [↕] ~ 0.010 [↕]	0.10 ~ 0.25 [↕]
0.3750 [↕]	9.52 [↕]	0.010 [↕] ~ 0.016 [↕]	0.20 ~ 0.46 [↕]	0.004 [↕] ~ 0.012 [↕]	0.10 ~ 0.30 [↕]

- Apex Angle(Tolerance) α 30 ~ 90[↕]
- Helix Angle Deg(Tolerance) β 15 ~ 30[↕]
- Number of Tooth(Number) 40 ~ 70[↕]

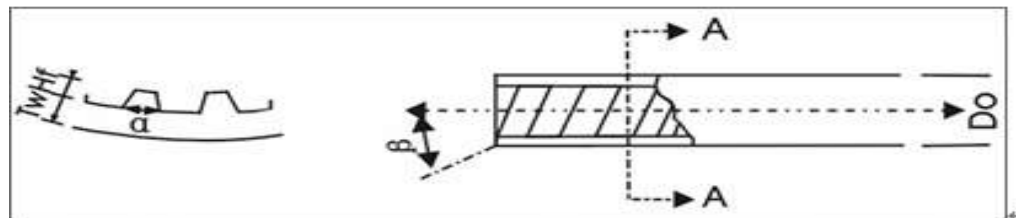

5. Supply of 5 mm copper tubes

Hailiang (Vietnam) supply inner grooved copper distribution

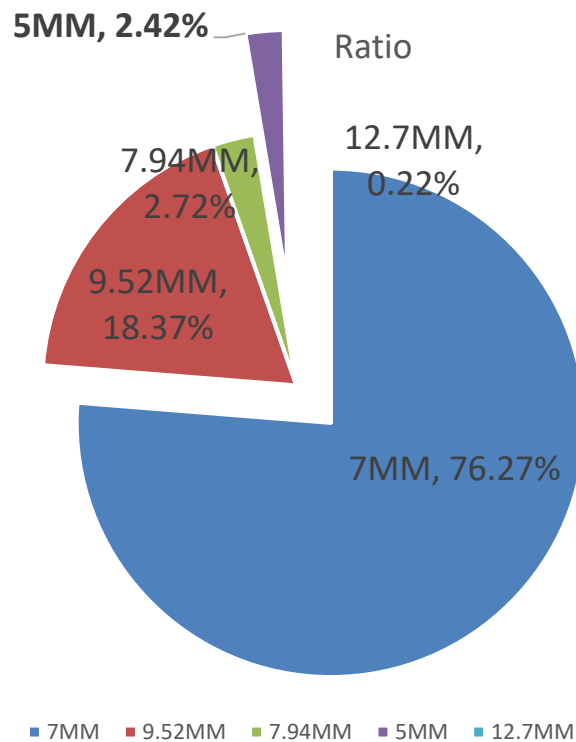

Hailiang(Vietnam) currently produces 1200 tons/month of inner grooved, and it is estimated that by March 2019, a new 1,000-ton/month line will be added.



Zhejiang Hailiang Co., Ltd

Address: Zhuji, Zhejiang, China

Zip code:311814

URL: <http://www.hailiangstock.com>

TEL: 0086-575-87063852 87063851

FAX: 0086-575-87067885 87069008

E-mail: foreigntrade@hailiang.com